

## Industrial Grade AC/DC Power Supply With PFC

85-264 Vrms Input Voltage	12/24/36/48 V Semi-Regulated Output	400 W Output Continuous	500 W Output Transient	Up to 91 % Full Load Efficiency
------------------------------	--	----------------------------	---------------------------	------------------------------------

# ACuQor®

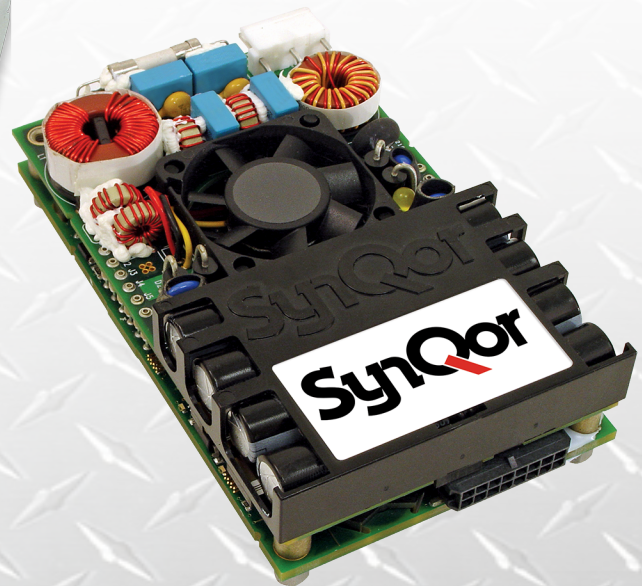

## Product Features

- High efficiency (91% for 48 VOUT Model at 400 W)
- Universal input voltage range
- Semi-regulated output for bus stability
- Parallel operation supported
- Integral fan cooling with speed control
- Active PFC; EN61000-3-2 compliant
- Low leakage; EN60601-1 compliant
- Low noise; EN55011 / EN55022 Class B compliant
- Over-current, over-voltage, & over-temp protection
- DC Power Good / AC Power Good signals
- Remote enable input
- Fan status output / Fan enable input
- Small size: 3" x 5" x 1.45" (open frame)
- RoHS 6/6 compliant
- 5 V (250 mW) standby output



# Technical Specification

**AC Input: 85-264 Vrms**  
**DC Output: 12/24/36/48 V Semi-reg.**  
**Power: 400 W**  
**Grade: Industrial**

## ACuQor 400W Series Electrical Characteristics

All specifications typical with  $T_A = 25\text{ }^\circ\text{C}$ , unless otherwise specified. Specifications subject to change without notice.

MAIN OUTPUT SPECIFICATIONS			GENERAL SPECIFICATIONS			
Output power (continuous) (5 s transient)	85-132/170-264 Vrms	400 W	Fundamental ripple freq.	Input	500 kHz	
	85-132/170-264 Vrms	500 W		Output	250 kHz	
	132-170 Vrms	See Figures 10		Audible noise		Fan speed varies with temp. 39 dBA @ 1 m max.
Nominal DC output voltage (at 250W) (Semi-regulated)	12 Vout	12.4 V	Weight (EA \ EC)	343 g (12.1 oz) \ 446 g (15.7 oz)		
	24 Vout	25 V		MTBF		MIL-217 343.6 kWhours
	36 Vout	37.5 V	<b>ISOLATION SPECIFICATIONS</b>			
	48 Vout	50 V	Isolation voltage	Input to output	3000 Vrms	
Efficiency (see figs. 3 - 10)	12 Vout, 115 Vrms, 400 W	88% typ.	Input to ground	1768 Vrms		
	48 Vout, 115 Vrms, 400 W	90% typ.	Output to ground	500 Vrms		
	12 Vout, 230 Vrms, 400 W	89% typ.	<b>ENVIRONMENTAL CHARACTERISTICS</b>			
	48 Vout, 230 Vrms, 400 W	91% typ.	Insulation resistance	Output to ground	10 MΩ min.	
Hold-up time (to -20%)	12 Vout	16 ms @ 400 W	Leakage currents			See Note 2
	24 / 36 / 48 Vout	20 ms @ 400 W	<b>ENVIRONMENTAL CHARACTERISTICS</b>			
Maximum load capacitance	12 Vout	16,000 μF	Thermal performance	Operating ambient (see Figure 2)	-40 °C to +70 °C	
	24 Vout	8,000 μF	Non-operating ambient		-40 °C to +85 °C	
	36 Vout	4,000 μF	Relative humidity	Non-condensing	5-95% RH	
	48 Vout	2,000 μF	Altitude	Operating	10,000 ft max.	
Output ripple voltage	Switching frequency (20 MHz BW)	0.5% p-p	Non-operating		30,000 ft max.	
	Twice line frequency (at 300W)	5.0% p-p	Random vibration	5-500 Hz	0.03 g2/Hz	
Turn-on delay		2 s max.	Shock	Half-sine, 10 ms, 3 axes	20 g peak	
Transient response	Iout steps from 50-75%	3% typ / 6% max. dev.	<b>EMC CHARACTERISTICS</b>			
	At 0.2 A/μs	100 ms recovery	Conducted emissions	EN55011 and EN55022, FCC part15	Level B	
Overvoltage protection	Cyclic restart	110-120%	Line frequency harmonics	EN61000-3-2	Class A	
Short circuit protection	Cyclic operation	115% rated Iout	Voltage fluctuations	EN61000-3-3	Clause 5b	
Total regulation	Over line, load and temperature	±6.0%	ESD air	EN61000-4-2	Level 3	
Auxillary Output	Always on (See Note 1)	5 V @ 50 mA	ESD contact	EN61000-4-2	Level 3	
Thermal protection	Automatic recovery	+125 °C (PCB Temp)	Radiated immunity	EN61000-4-3	Level 3	
REMOTE_ENABLE	Input Low Voltage	0.45 V (max)	Fast transients	EN61000-4-4	Level 3	
	Input High Voltage	4.15 V (min)	Line surge immunity	EN61000-4-5	Level 3	
<b>INPUT SPECIFICATIONS</b>			Conducted immunity	EN61000-4-6	Level 3	
AC input voltage	Universal range	85-264 Vrms	Power freq. mag. field	EN61000-4-8	3 A/m	
Input frequency		47-63 Hz	Voltage dip immunity	EN61000-4-11	Perf Criteria A, A, B <5% UT 10 ms, 70% UT 500 ms, 40% UT 100 ms	
Input current	115 Vrms @ 400 W	4 Arms				
	230 Vrms @ 400 W	2 Arms				
Power factor		>0.98				
Input surge current	264 Vrms (cold start)	40 A max.				
Internal input fuses	Both AC lines	6.3 A				

**NOTES:**

- Derate 1mA per °C above 50 °C ambient temperature
- Leakage currents see page 5.

### EFFICIENCY, DERATING, AND VOUT DROOP CURVES

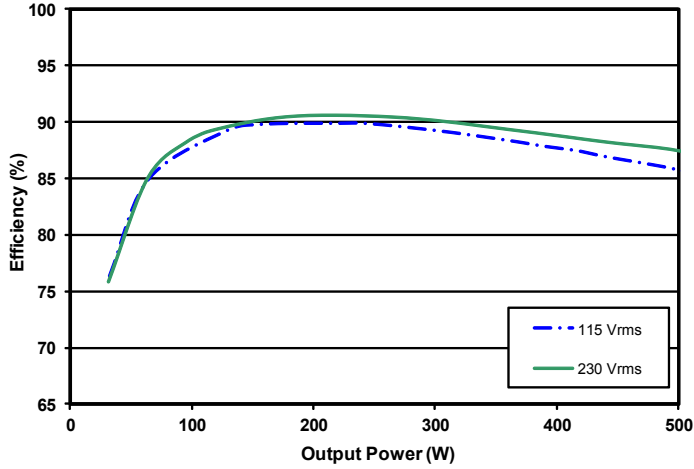

Figure 1: 12  $V_{OUT}$  efficiency curves.

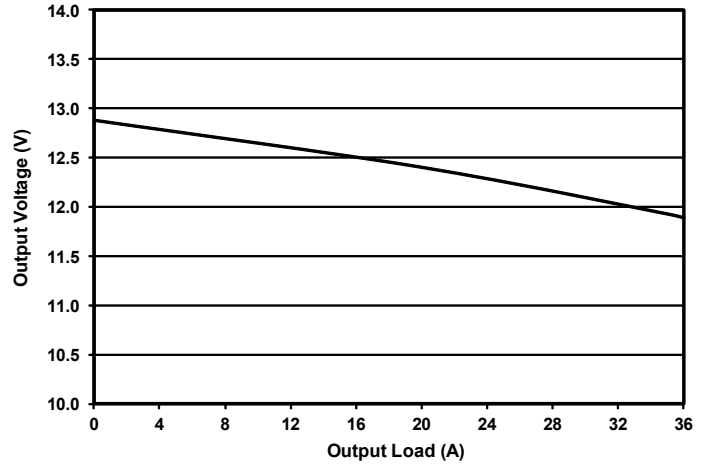

Figure 2: 12  $V_{OUT}$  droop characteristic.

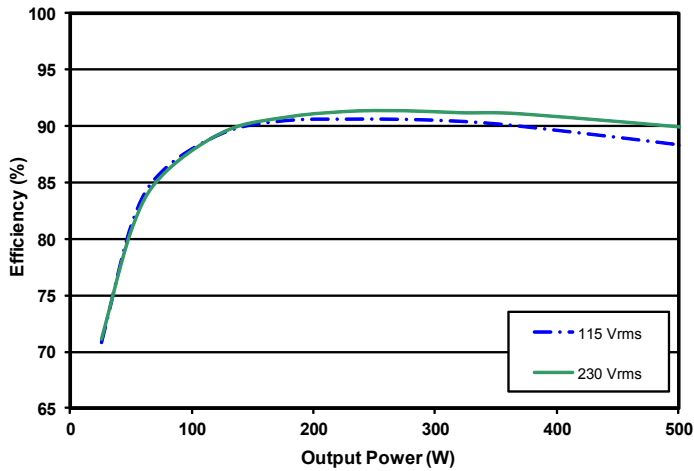

Figure 3: 24  $V_{OUT}$  efficiency curves.

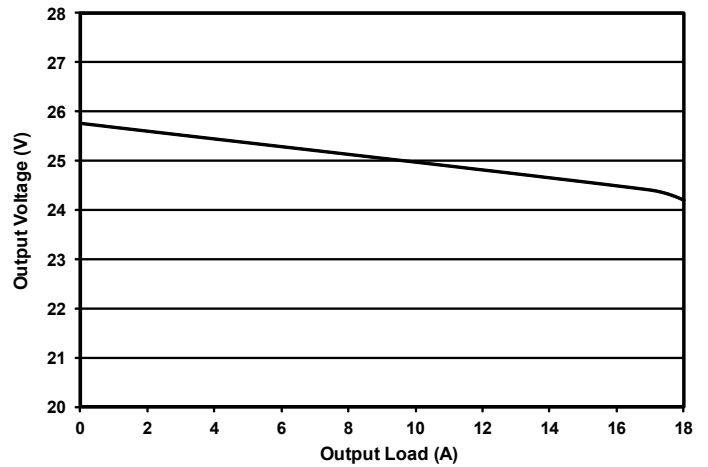

Figure 4: 24  $V_{OUT}$  droop characteristic.

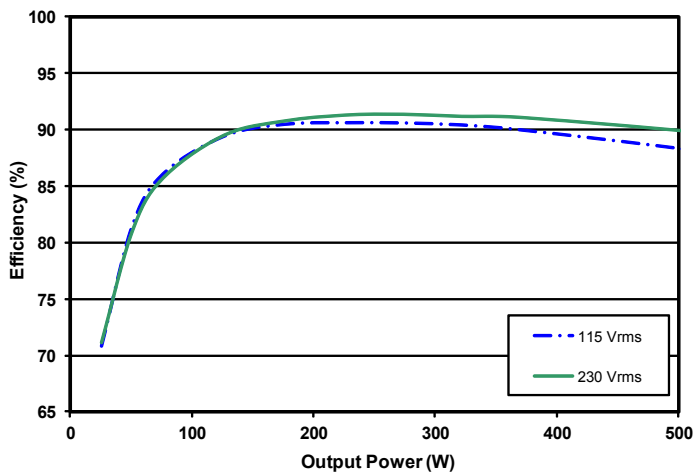

Figure 5: 36  $V_{OUT}$  efficiency curves.

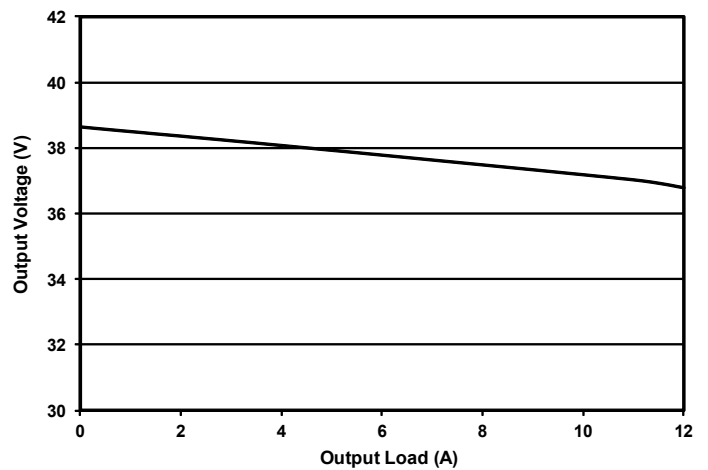

Figure 6: 36  $V_{OUT}$  droop characteristic.

### EFFICIENCY, DERATING, AND VOUT DROOP CURVES

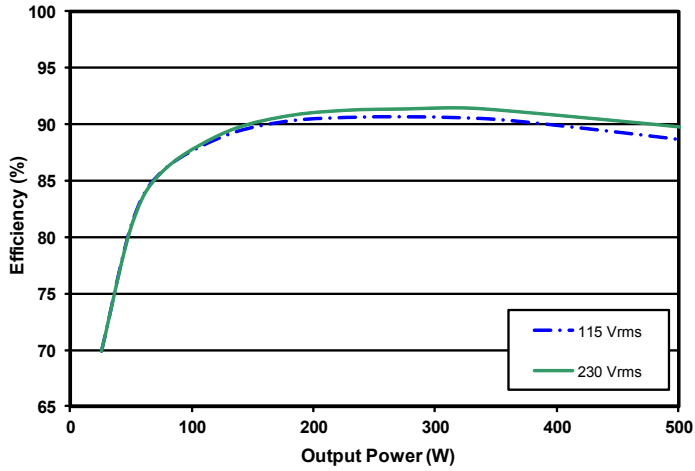

Figure 7: 48 V<sub>OUT</sub> efficiency curves.

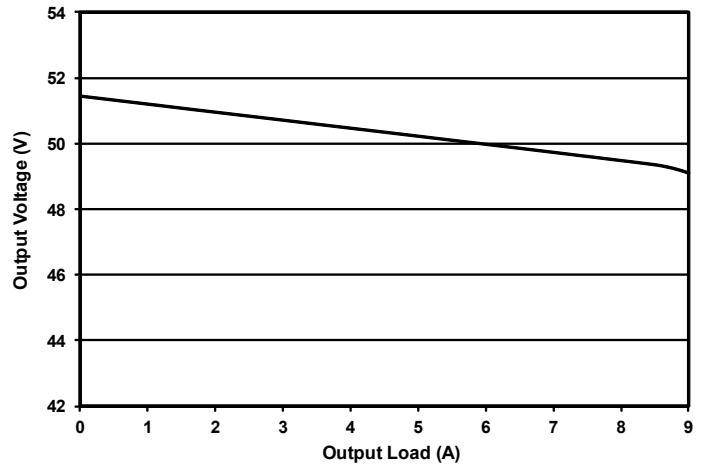

Figure 8: 48 V<sub>OUT</sub> droop characteristic.

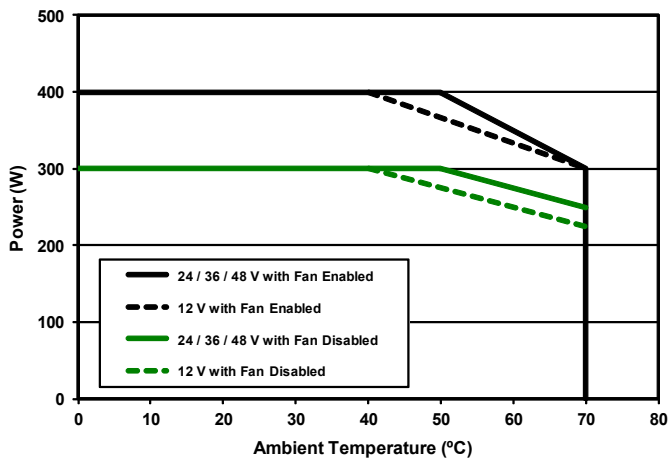

Figure 9: Continuous power derating curve in natural convection

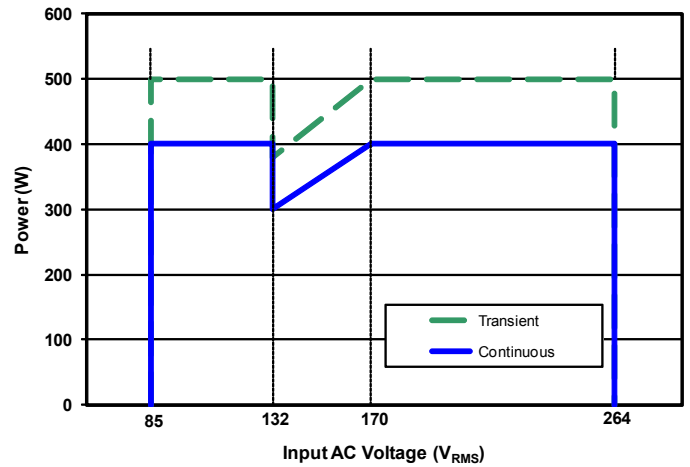

Figure 10: Rated output power vs Input AC Voltage



## Technical Specification

**AC Input:** 85-264 Vrms  
**DC Output:** 12/24/36/48 V Semi-reg.  
**Power:** 400 W  
**Grade:** Industrial

### Leakage Currents

AC Leakage Current from Input to Earth	AC Line Connection	Normal Condition	Open Neutral Fault
ACuQor Typical at 110% nominal input voltage 60 Hz	240 V L-N, 1 phase	400 $\mu$ A	800 $\mu$ A
	208 V L-L, 120 V L-N, 1 of 3 phases	200 $\mu$ A	400 $\mu$ A
	240 V L-N-L, 120 V L-N, split phase	200 $\mu$ A	400 $\mu$ A

### Standard Testing Certifications

#### SAFETY AGENCY CERTIFICATIONS

CAN/CSA-C22.2 No. 62368-1

UL 62368-1

EN 62368-1

CE Marked

## CONNECTOR DETAILS

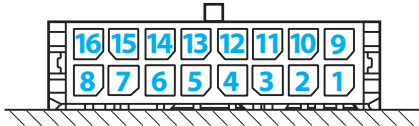

### OUTPUT CONNECTOR PINOUT (top side)

Pin 1	FAN_GOOD	Open collector with internal 5V pullup. See Figure A. Pulsed low on fan failure, 100ms, 50% duty. Short to VOUT(-) to disable fan.
Pin 2	AC_POWER_GOOD	Open collector with internal 5V pullup. See Figure B. Pulled low on AC power dropout.
Pin 3	DC_POWER_GOOD	Open collector with internal 5V pullup. See Figure B. Pulled low during startup ramp and within 5 °C of temperature shutdown threshold.
Pin 4	5V_STANDBY	5 V @ 50 mA available whenever AC power is applied.
Pin 5	VOUT(+)	Positive Output Voltage.
Pin 6	VOUT(+)	Positive Output Voltage.
Pin 7	VOUT(+)	Positive Output Voltage.
Pin 8	VOUT(+)	Positive Output Voltage.
Pin 9	Reserved	Reserved for future use.
Pin 10	Reserved	Reserved for future use.
Pin 11	REMOTE_ENABLE	Logic input. See Figure C. Pull high to enable main output.
Pin 12	VOUT(-)	Negative Output Voltage.
Pin 13	VOUT(-)	Negative Output Voltage.
Pin 14	VOUT(-)	Negative Output Voltage.
Pin 15	VOUT(-)	Negative Output Voltage.
Pin 16	VOUT(-)	Negative Output Voltage.

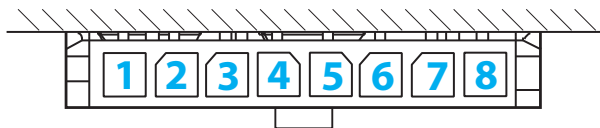

### 12 V OUTPUT CONNECTOR PINOUT (bottom side)

Pin 1	VOUT(+)	Positive Output Voltage.
Pin 2	VOUT(+)	Positive Output Voltage.
Pin 3	VOUT(+)	Positive Output Voltage.
Pin 4	VOUT(+)	Positive Output Voltage.
Pin 5	VOUT(-)	Negative Output Voltage.
Pin 6	VOUT(-)	Negative Output Voltage.
Pin 7	VOUT(-)	Negative Output Voltage.
Pin 8	VOUT(-)	Negative Output Voltage.

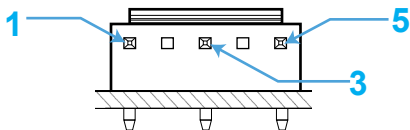

### INDIVIDUAL INPUT CONNECTOR PINOUT

Pin 1	Ground
Pin 3	AC Neutral
Pin 5	AC Line

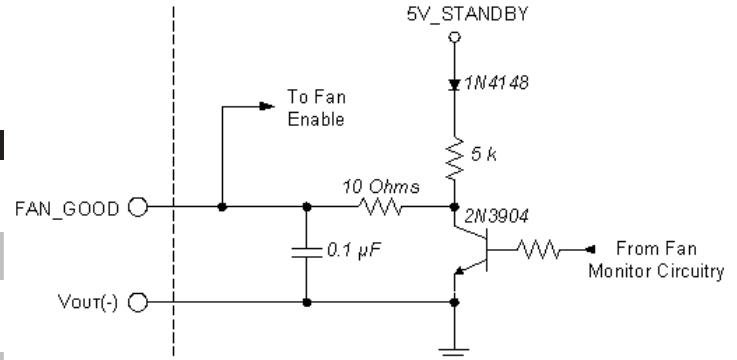

Figure A: Fan status output / Fan enable input interface circuitry.

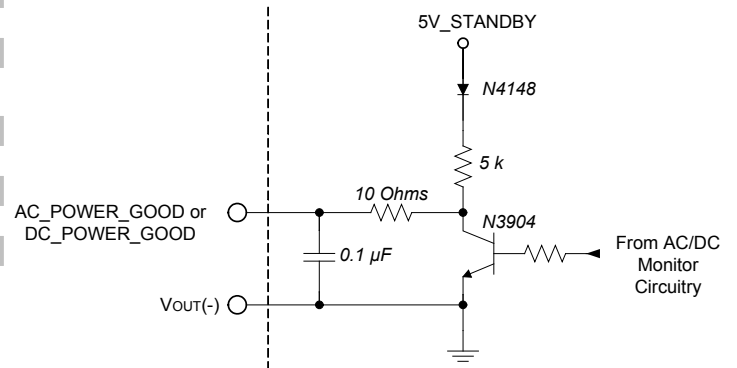

Figure B: Power good interface circuitry.

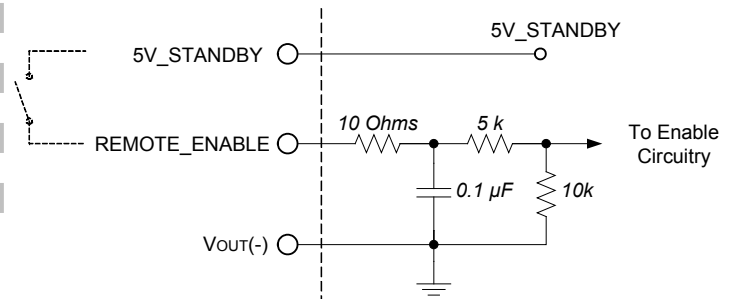

Figure C: Remote enable interface circuitry.

### MATING CONNECTORS

Connector	Type	Contact
OUTPUT (16 pins)	Molex 430251600	Molex 430300008*
12V_OUTPUT (8 pins)	Molex 436450800	Molex 430300008*
INPUT	JST VHR-5N	JST SVH-41T-P1.1

\* Each contact rated for a maximum of 5.5 A.

### MECHANICAL DRAWINGS

#### (1 Module Open Frame Version — E Package Type)

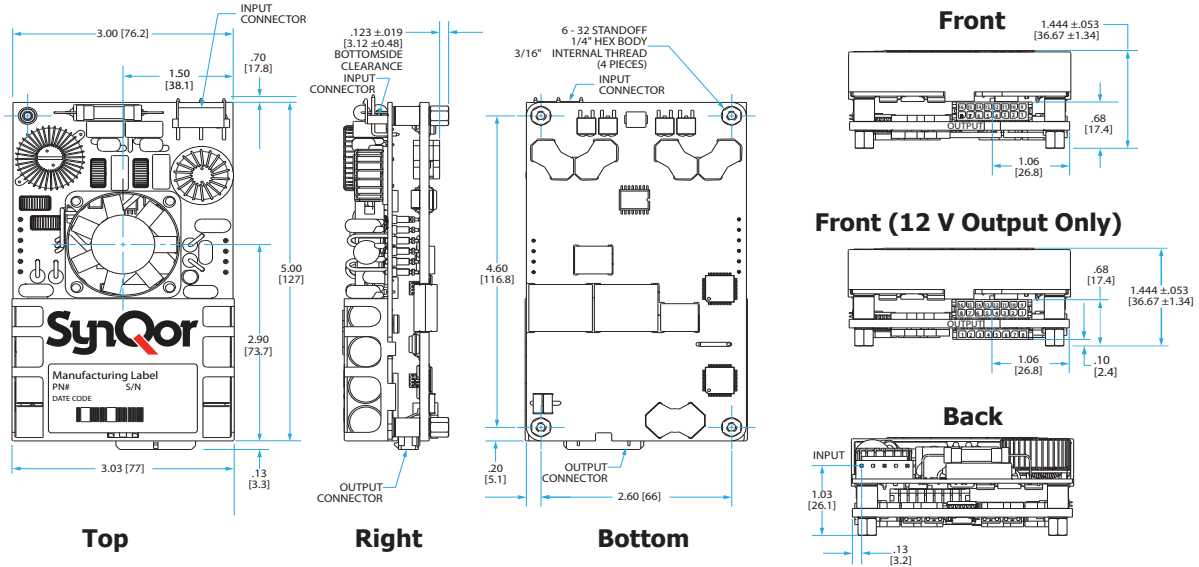

#### (1 Module Encased Version — E Package Type)

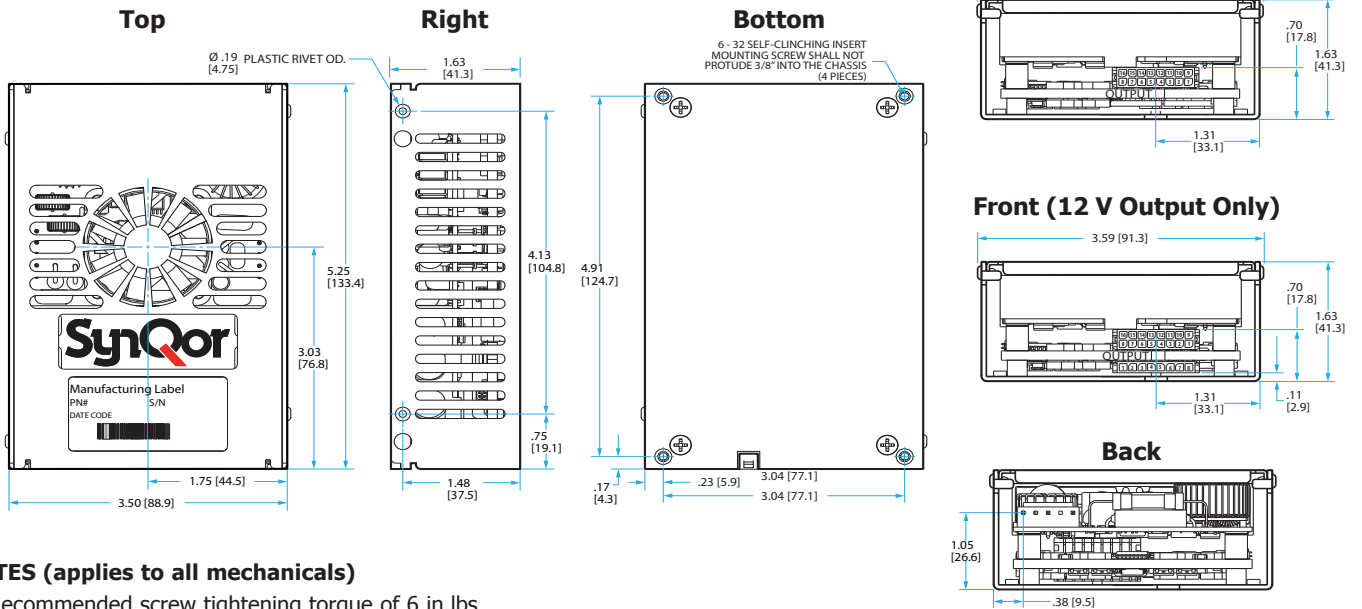

#### NOTES (applies to all mechanicals)

- 1) Recommended screw tightening torque of 6 in.lbs
- 2) Undimensioned components are shown for visual reference only
- 3) All dimensions in inches [mm]

Tolerances: x.xx in ± 0.02  
x.xxx in ± 0.010

### PARALLEL OPERATION - MULTIPLE UNITS

The following table summarizes the recommended wiring to operate multiple units in parallel.

As a rule, units wired in parallel behave the same as single units. Any specification will remain unchanged that is expressed in units of voltage, time, frequency, or efficiency. Specifications expressed in terms of power, current, or capacitance, should be scaled by the number of units wired in parallel.

ACuQor units are individually calibrated at the factory, so that the output voltage vs. output current characteristic is always consistent (see Vout droop characteristic figures). As such, multiple units will share output current accurately. Full current is guaranteed from a bank of multiple units wired in parallel.

Output Connector Signal	Suggested Connection	Behavior with Multiple Units
REMOTE_ENABLE	Wire in parallel	Inputs activated simultaneously
FAN_GOOD	"	Wired-OR outputs – can be pulled low by any unit during an abnormal condition.
AC_POWER_GOOD	"	"
DC_POWER_GOOD	"	"
VOUT(+), VOUT(-)	"	Built-in droop characteristic ensures graceful current sharing.
12V_STANDBY*	"	"
5V_STANDBY	Do not wire in parallel	Fully regulated characteristic does not support current sharing. If placed in parallel, only the output with the highest set-point will drive current.

\*Note: Triple output models only.



## INSTALLATION INSTRUCTIONS

**General:** ACuQor AC/DC power supplies are intended for use as components in industrial equipment. ACuQor units must be properly installed within end use equipment before they can be safely applied as described in this document. The suitability of the ACuQor/equipment combination must be verified through end product investigation.

**Mounting:** Refer to the Mechanical Drawings section. ACuQor units are provided with threaded stainless-steel stand-offs or inserts for mounting. This mounting hardware is internally connected to the input connector protective-earth terminal for functional-earth EMC control. Any orientation (vertical, horizontal, etc.) may be used. Adequate air space should be provided over the fan intake (top) and exhaust (sides) to allow for exchange of cooling air. ACuQor is designed for a pollution degree 2 environment. The suitability of the enclosed ACuQor mechanical assemblies must be verified through end product investigation.

**Encased models:** A minimum of 5 mm electrical clearance should be allowed from the connector ends of encased models.

**Input:** Refer to the Connector Details section for input connector wiring. ACuQor products require a single phase AC power source of 100-240V 50/60Hz nominal. Refer to nameplate label for input current ratings. A protective-earth connection is also required. Minimum wire size of 18 AWG (0.8mm<sup>2</sup>) is recommended. Both sides of the AC line are internally fused (see table for specific models). These fuses are not user replaceable.

**Output:** Refer to the Connector Details section for the output connector wiring and signal I/O functionality. Refer to nameplate label for output current ratings. Main DC output (Vout+, Vout-) pins should use 20 AWG (0.5mm<sup>2</sup>) wire size. Individual main output pins should not be loaded to more than 5.5 A. For currents greater than 5.5 A, multiple main output pins/wires must be used in parallel. All signal I/O pins are referenced to Vout-.

**EMC:** ACuQor products have been tested to the EMC specifications listed in the Electrical Characteristics section. However, end use equipment must be tested to verify EMC compliance.

**HIPOT Testing:** ACuQor products are rated for Hipot testing levels of 1768 Vac input to protective-earth, 500 Vac output to protective-earth, and 3000 Vac input to output. When performing the 3000 Vac input to output test, the test voltage must be balanced evenly 1500 Vac input and output to protective-earth. Two oppositely phased test voltage sources or a single test voltage source with external balancing impedances (capacitors) may be used to prevent overstressing input or output to protective-earth insulation per IEC/EN 62368-1.

MODEL	Input Fuses (in Both AC Lines)	Fuses Total
AQ0300	Littelfuse 6.3A 250V 21606.3XEP	2
AQ0400	Littelfuse 6.3A 250V 21606.3XEP	2
AQ0500	Littelfuse 10.0A 250V 216010XEP	2



# Ordering Information

**AC Input: 85-264 Vrms**  
**DC Output: 12/24/36/48 V Semi-reg.**  
**Power: 400 W**  
**Grade: Industrial**

## PART NUMBERING SYSTEM

The part numbering system for SynQor's ACuQor AC/DC power supplies follows the format shown in the table below. Not all combinations make valid part numbers, please contact SynQor for availability.

Family	Output Power	Grade	Range	Output Voltage	Package Type	Thermal Design	Options
AQ: ACuQor series of AC-DC semi-regulated output power supplies	0300: 300 W 0400: 400 W 0500: 500 W	I: (Industrial)	U: Universal (85-264 VRMS)	12: 12 V 1T: 12 V / 5 & 12 V STBY 24: 24 V 2T: 24 V / 5 & 12 V STBY 36: 36 V 3T: 36 V / 5 & 12 V STBY 48: 48 V 4T: 48 V / 5 & 12 V STBY	E: 1 unit (3"x5")	A: Open frame C: Encased	Industrial Grade: IND: Industrial

Example: AQ0400IU12ECIND

## ACCESSORIES

SynQor offers a series of assemblies that can be ordered according to the table below. Mechanical drawings for these accessories are available for download in pdf format from the SynQor website.

Part Number	Description
<b>AQ-CBL-INPUT1C</b>	Input mating cable with pre-stripped wire ends (36" long).
<b>AQ-CBL-OUT1C</b>	Output mating cables with pre-stripped wire ends (18" long).
<b>AQ-CBL-OUT1CD</b>	Same as AQ-CBL-OUT1C with an additional 8-pins connector.
<b>AQ-CBL-OUT2C</b>	Output mating cable with connectors on both ends (18" long).
<b>AQ-CBL-OUT2CD</b>	Same as the AQ-CBL-OUT2C with an additional 8-pins connector.
<b>AQ-INSUL1M</b>	Single module bottom-side Mylar insulator for open frame mounting
<b>AQ-EVAL-PRL3</b>	Evaluation board for up to three paralleled modules.

## APPLICATION NOTES

A variety of application notes and technical white papers can be downloaded in pdf format from the SynQor website.

[Online Application Notes](#)

[Online Library of Technical White Papers](#)

[SynQor website.](#)

## Contact SynQor for further information and to order:

Phone: 978-849-0600 Toll Free: 888-567-9596 Fax: 978-849-0602

E-mail: [power@synqor.com](mailto:power@synqor.com) Web: [www.synqor.com](http://www.synqor.com)

Address: 155 Swanson Road, Boxborough, MA 01719 USA

## PATENTS

SynQor holds numerous U.S. patents, one or more of which apply to most of its power conversion products. Any that apply to the product(s) listed in this document are identified by markings on the product(s) or on internal components of the product(s) in accordance with U.S. patent laws. SynQor's patents include the following:

7,050,309 7,765,687 7,787,261  
 8,149,597 8,644,027

## WARRANTY

SynQor offers a two (2) year limited warranty. Complete warranty information is listed on our website or is available upon request from SynQor.